



London

Bancs et table pour des endroits
très fréquentés



london ZL



london ML



dimensions

51 kg

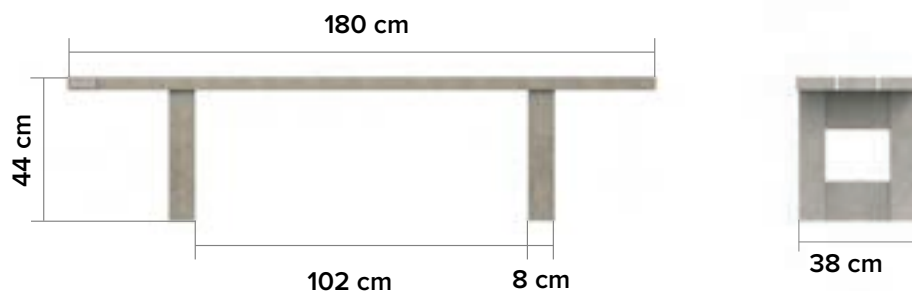

couleurs disponibles

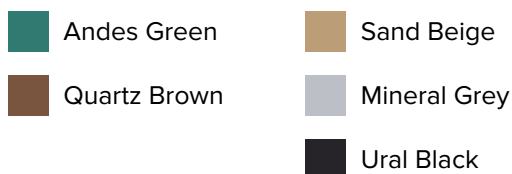

options bicolor

Planches

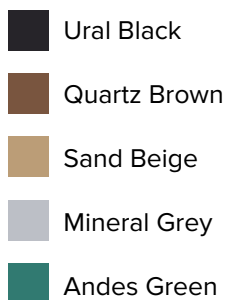

Pieds



principaux atouts



100% déchets plastiques



Sans entretien



Imputrescible



Aspect naturel



Graffiti s'enlève facilement



Sans éclardes



Peinté dans la masse



Résistant aux intempéries



Complètement recyclable

dimensions

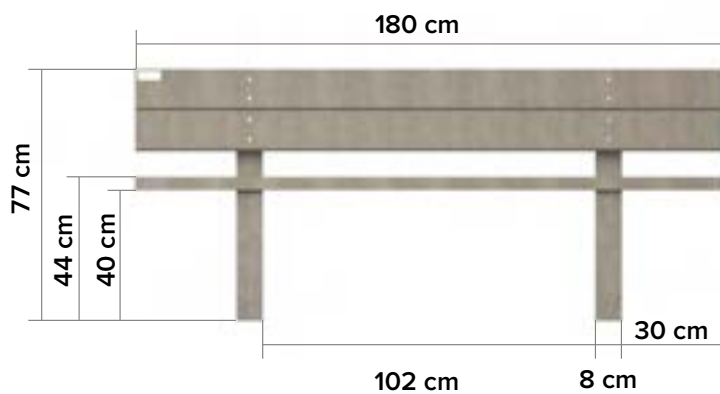

51 kg
avec dossier: 87 kg



couleurs disponibles

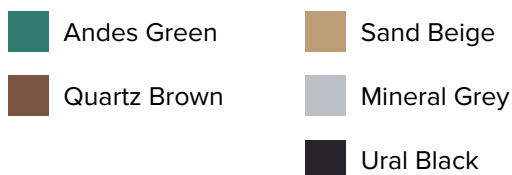

options bicolor

Planches

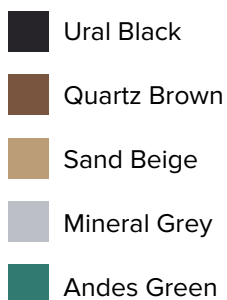

Pieds



principaux atouts



100% déchets plastiques



Sans entretien



Imputrescible



Aspect naturel



Graffiti s'enlève facilement



Sans échardes



Peinté dans la masse



Résistant aux intempéries



Complètement recyclable

ancrage

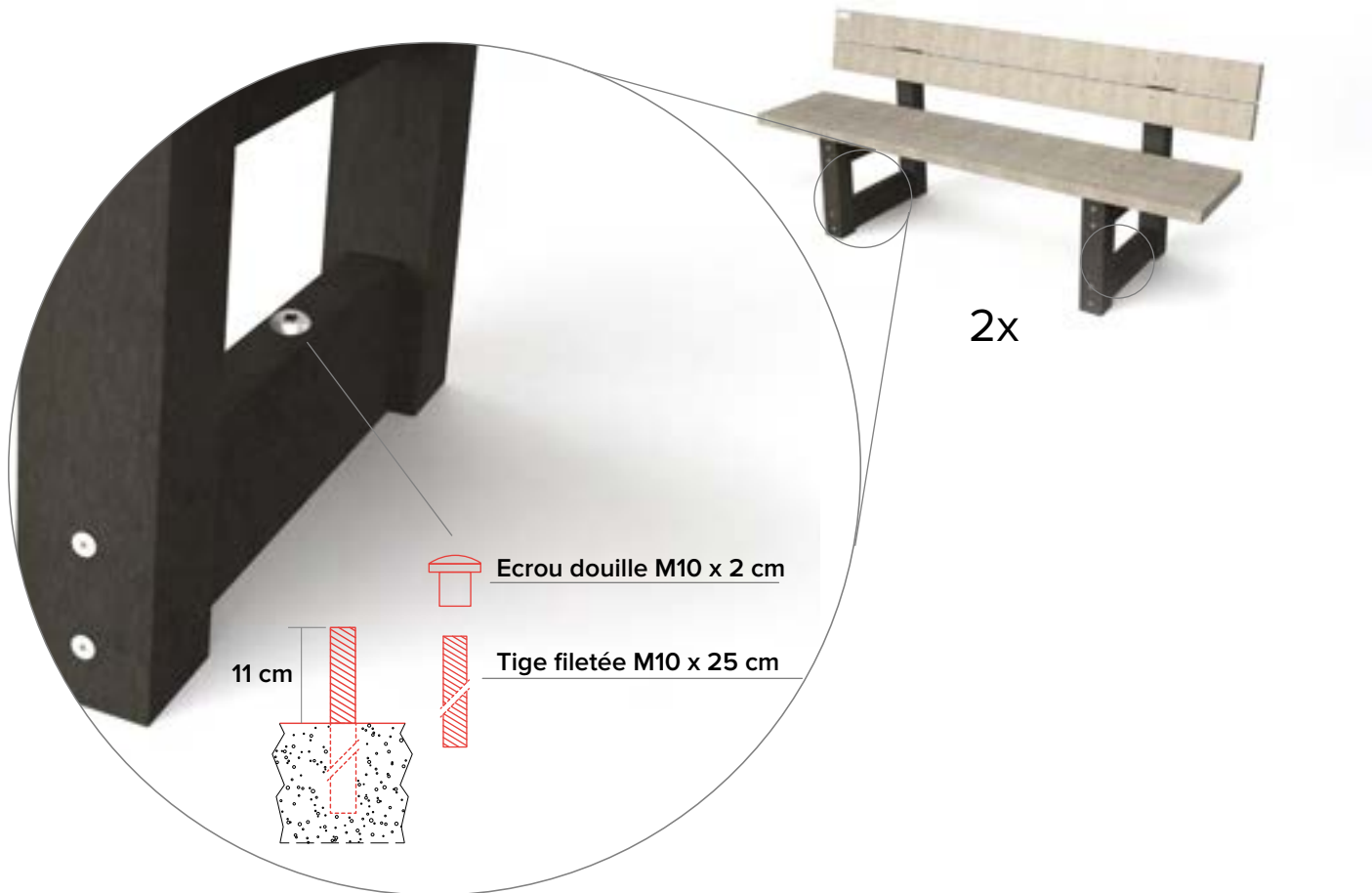

renforcement



à combiner avec

